

# SMART LOCK INSTRUCTIONS

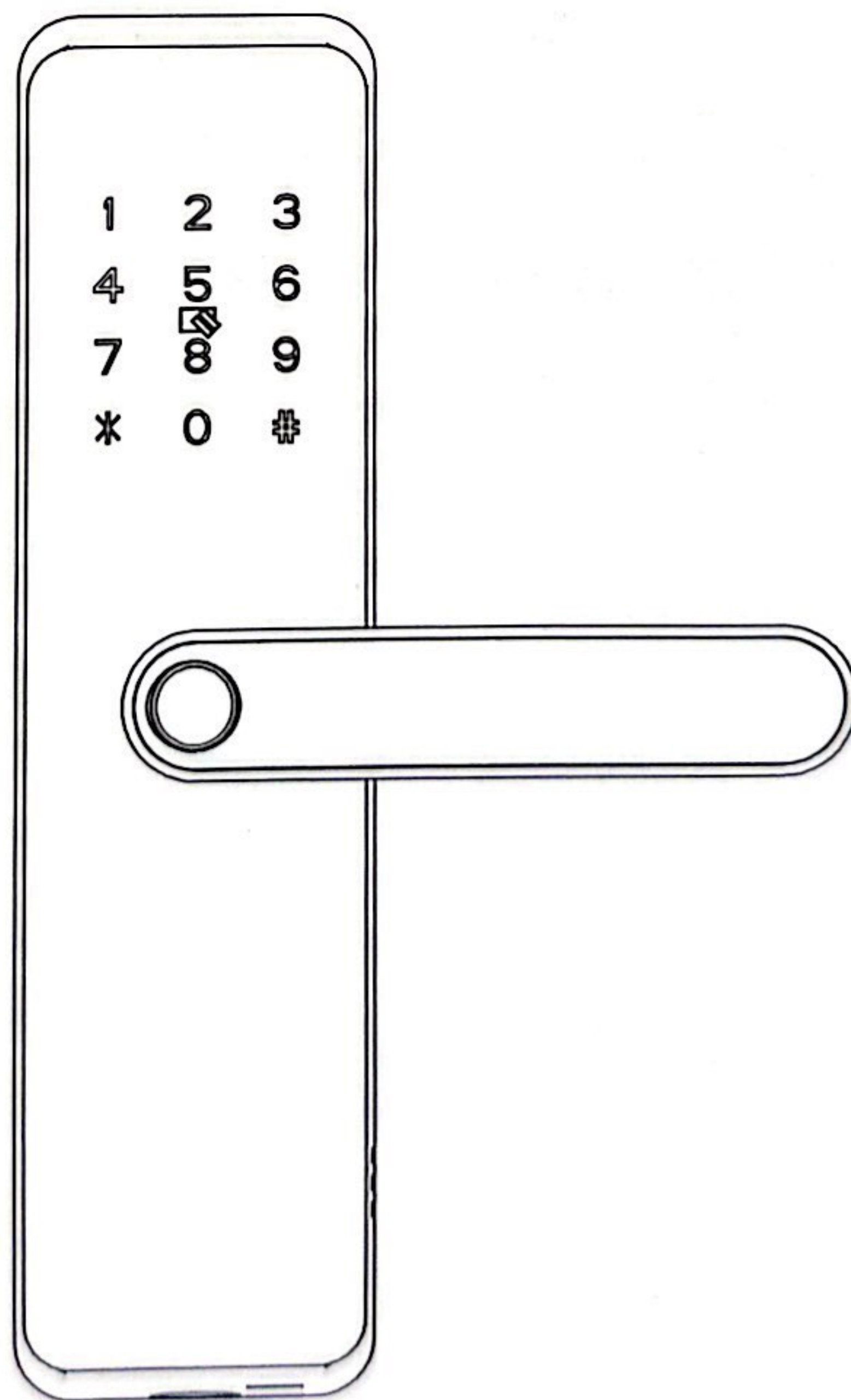

# Content

Technical parameter	01
Instruction/Product drawing	02
Product list/Installation diagram	03
Preparation before installation	04
Smart lock installations	06
Installation test	08
Function introductions	08
Product setting	08

# Technical parameter

No	Project	Parameter
1	Product size	234×64×18mm
2	Main material	Zinc alloy
3	Battery power	6V DC
4	Quiescent dissipation	<50uA
5	Dynamic power dissipation	<300mA
6	Digits of password	Valid 6-12 digits
7	Card reading distance	5-20mm
8	Anti radiation interference	10V/m
9	Operation humidity	10%-90%
10	Operation temperature	-20°C-60°C
11	Fingerprint collection	Semiconductor collector
12	Fingerprint collecting time	<0.5seconds
13	False reject rate	<=0.1%
14	False accept rate	<=0.0001%
15	Expansion module	Bluetooth
16	Emergency power supply	5V Micro USB
17	Antistatic	Contact discharge 8KV/Air discharge 15KV
18	Low-Battery alarm	4.8V
19	Door type	Timber door/Security door
20	Door thickness	35mm to 55mm

## Instruction/Product drawing

1. The outgoing products could use any 6 digits password number, any fingerprint and card to open. Please add the username in time.
2. The normal operation and working duration of fingerprint & password unlocking system which is a high-tech product will be affected by installation quality directly; therefore, an experienced professional is suggested to install the products, and please follow the instructions strictly.
3. Please do not mix with old and new batteries or different model of batteries during replacing.
4. Please follow the voice prompts during setup and operation, normally, requested operation is followed after corresponding voice prompt.
5. Please keep the emergency key properly just in case; Please do not keep all the emergency keys indoor.

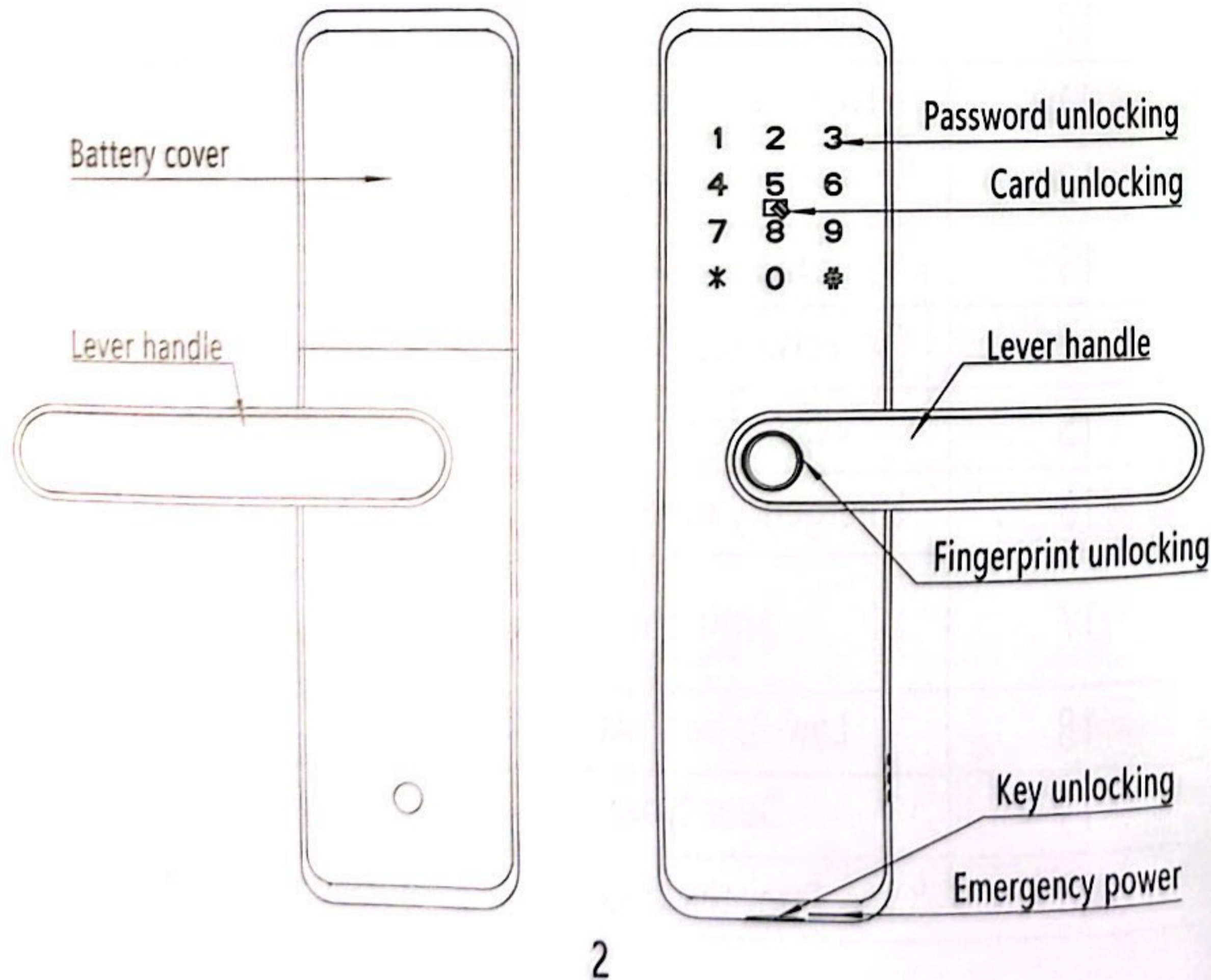

## Product list/Installation diagram

Please check the list below carefully before installation, if there is anything missing, please contact us or our agents in time.

No	Name	Quantity	Comment
1	Front Panel Unit	1	Including silicone pad
2	Back Panel Unit	1	Including silicone pad
3	Lock Body Suites	1	Including Accessories
4	Key	2	
5	Door Card	2	
6	Accessory Bag	1	
7	Hole template	1	
8	Instruction	1	

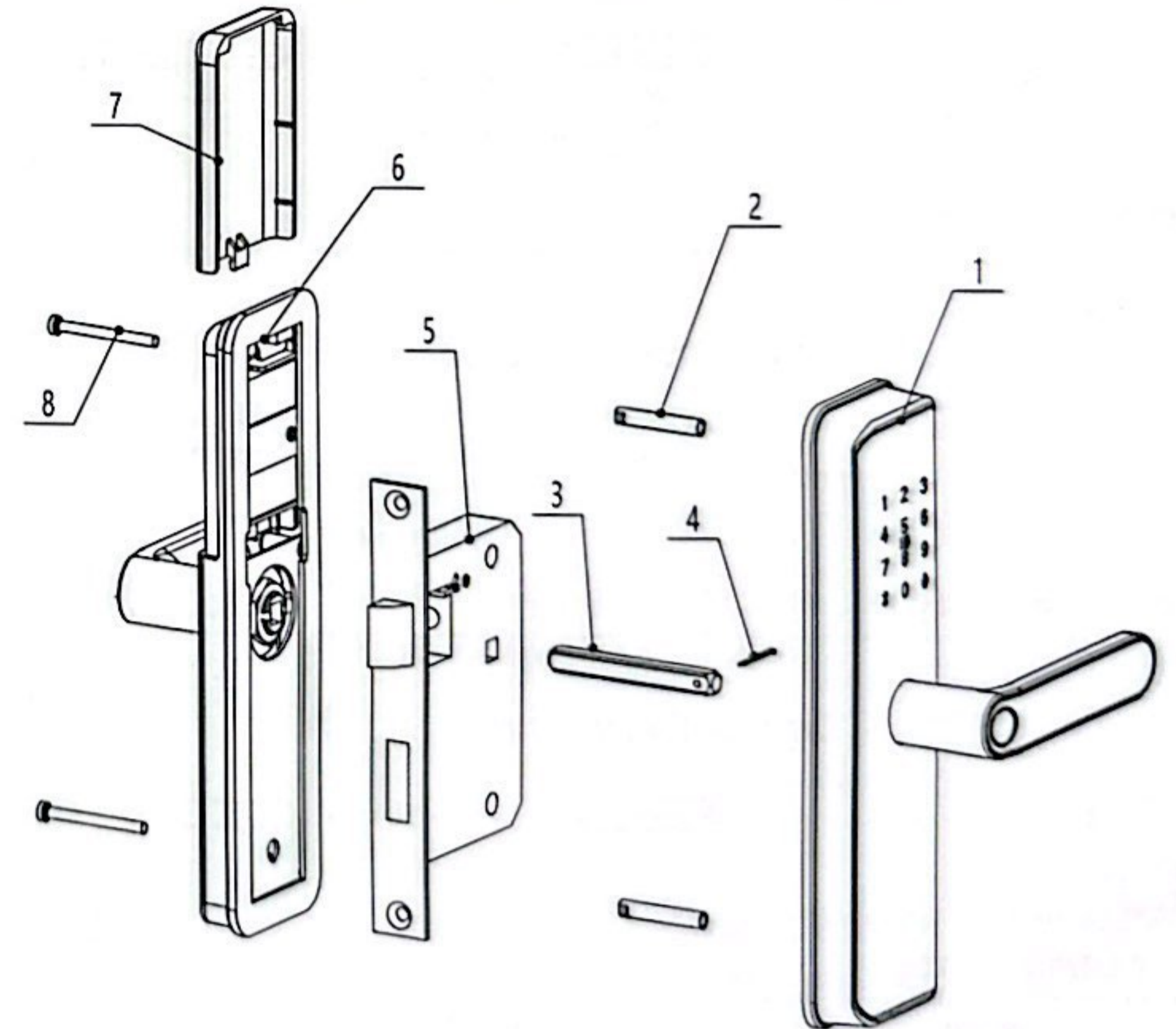

1. Front panel unit    2. Connecting solenoid    3. Square bar    4. cotter  
 5. Lock body    6. Back panel unit    7. Battery cover    8. Connecting screw

3

# Preparation before installation

## 1. Judge the door opening direction

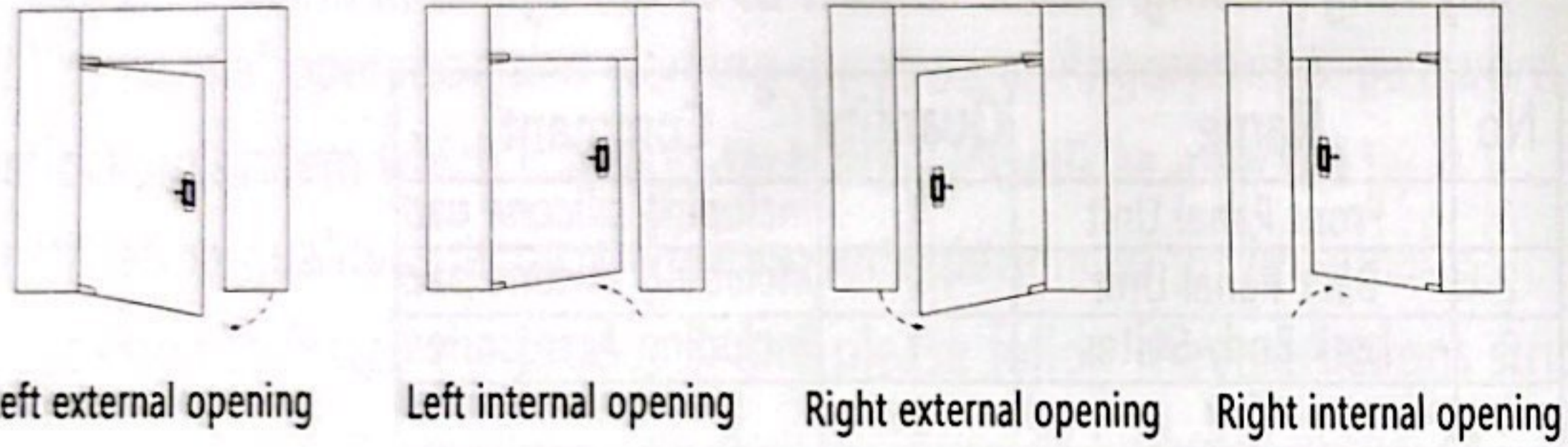

## 2. Corresponding direction of latch bolt and lever handle for opening direction

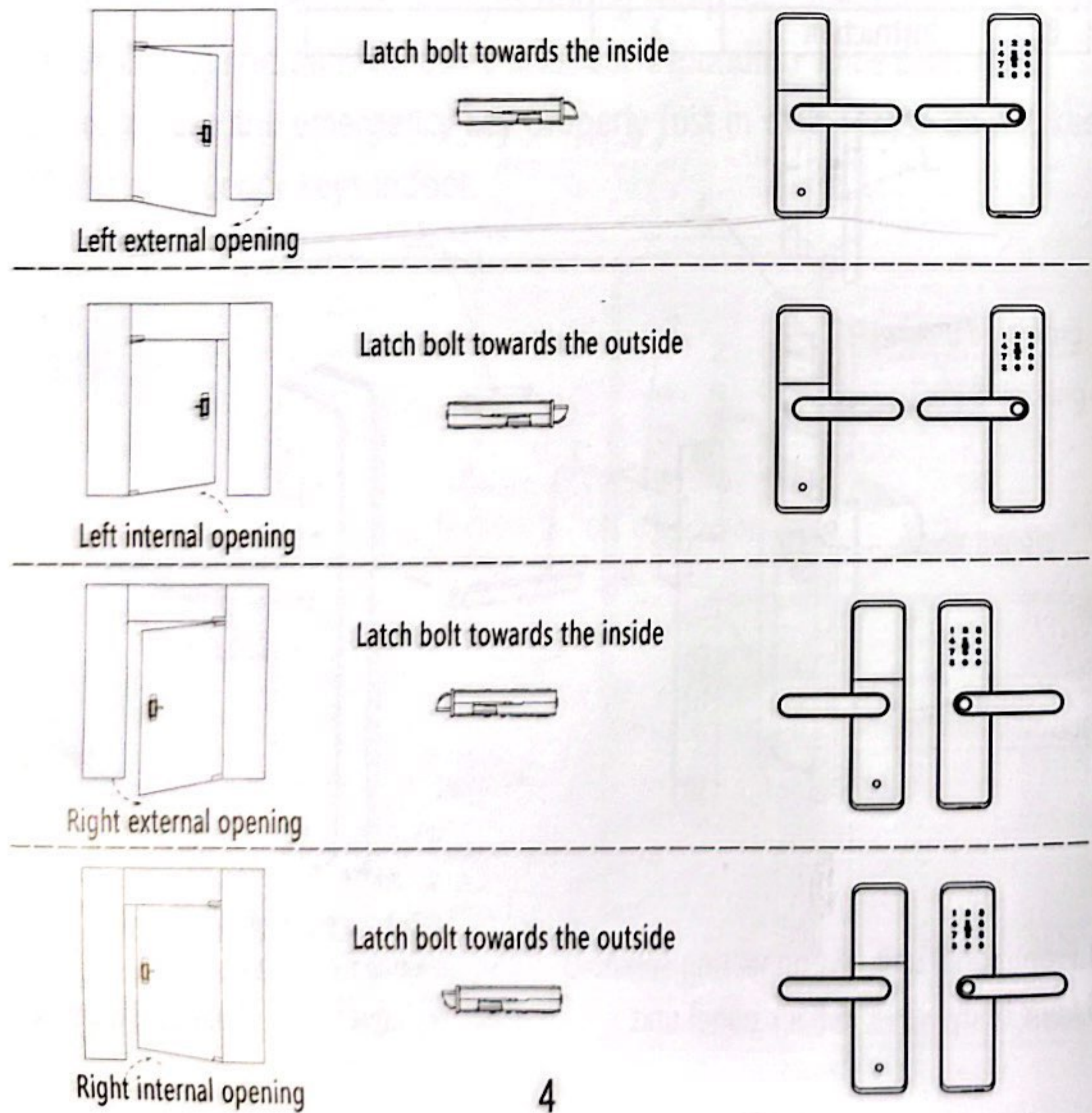

## 3. Direction of latch bolt

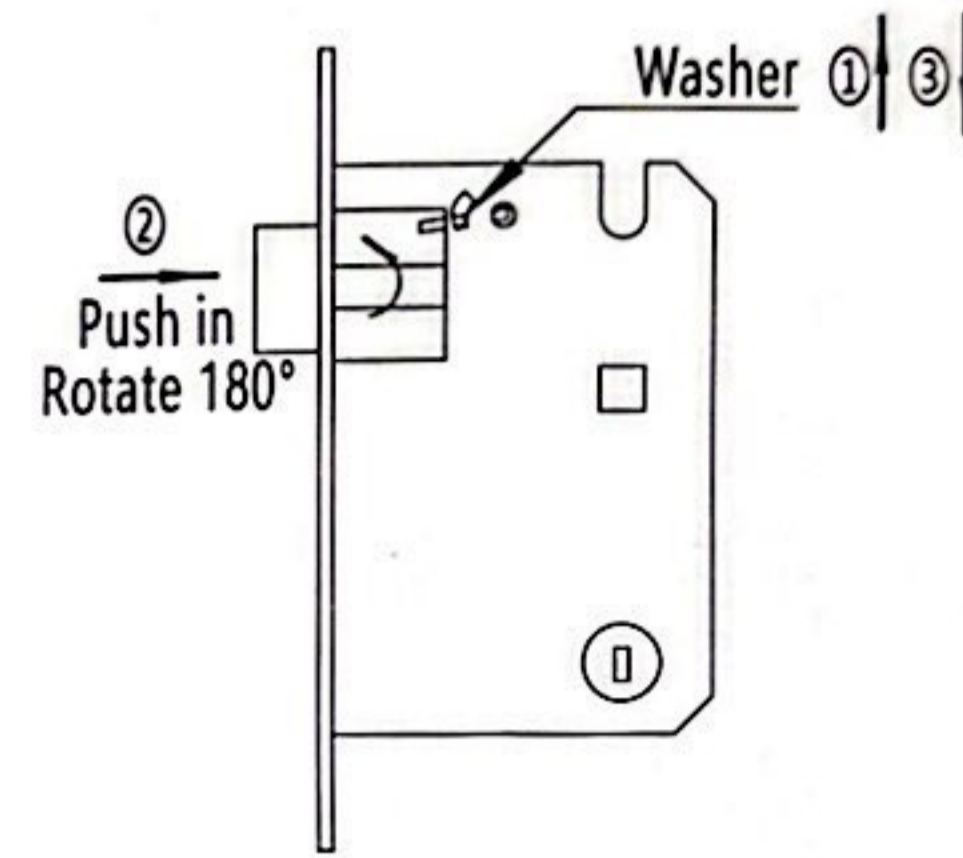

- ① Push the latch bolt washer to the top
- ② Push the latch bolt into lock body, rotate 180 degree, then pull out the latch bolt
- ③ At last, push the latch bolt washer to the bottom

## 4. Direction of lever handle

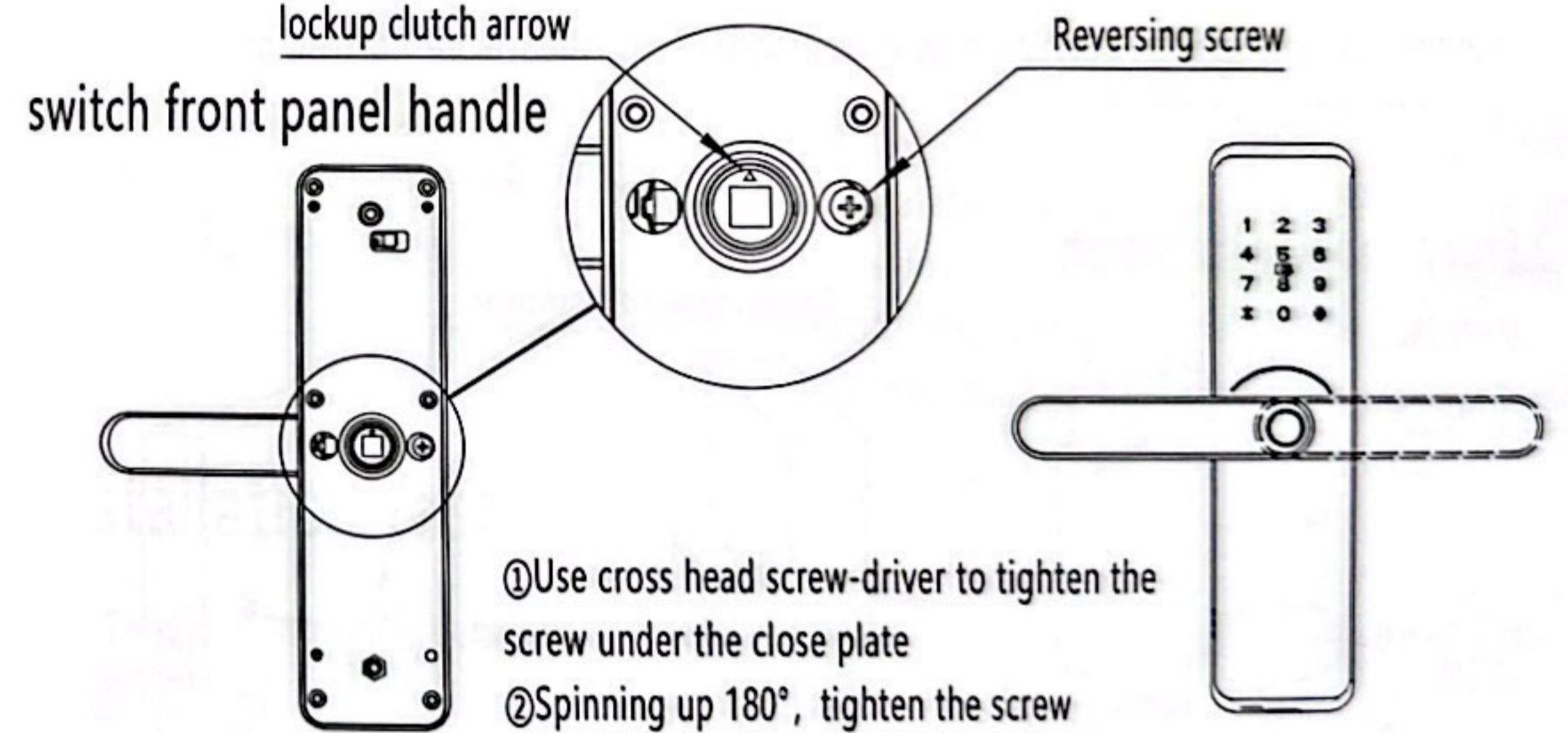

## switch back panel handle

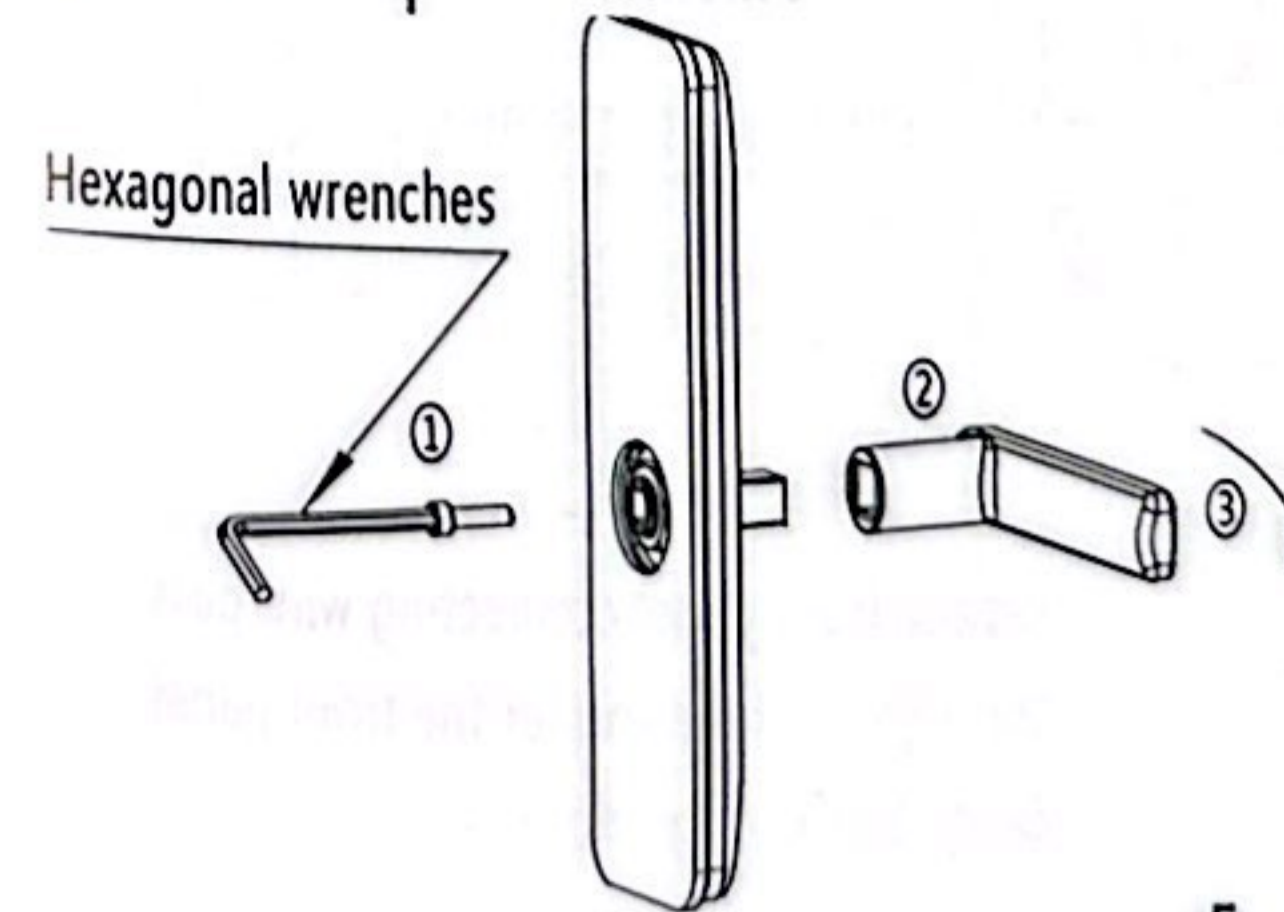

- ① Use hexagonal wrenches to remove reversing screw
- ② Remove lever handle
- ③ Exchange the left/right and also tighten the reversing screw

5

# Smart lock installations

## 1.Lock body installation

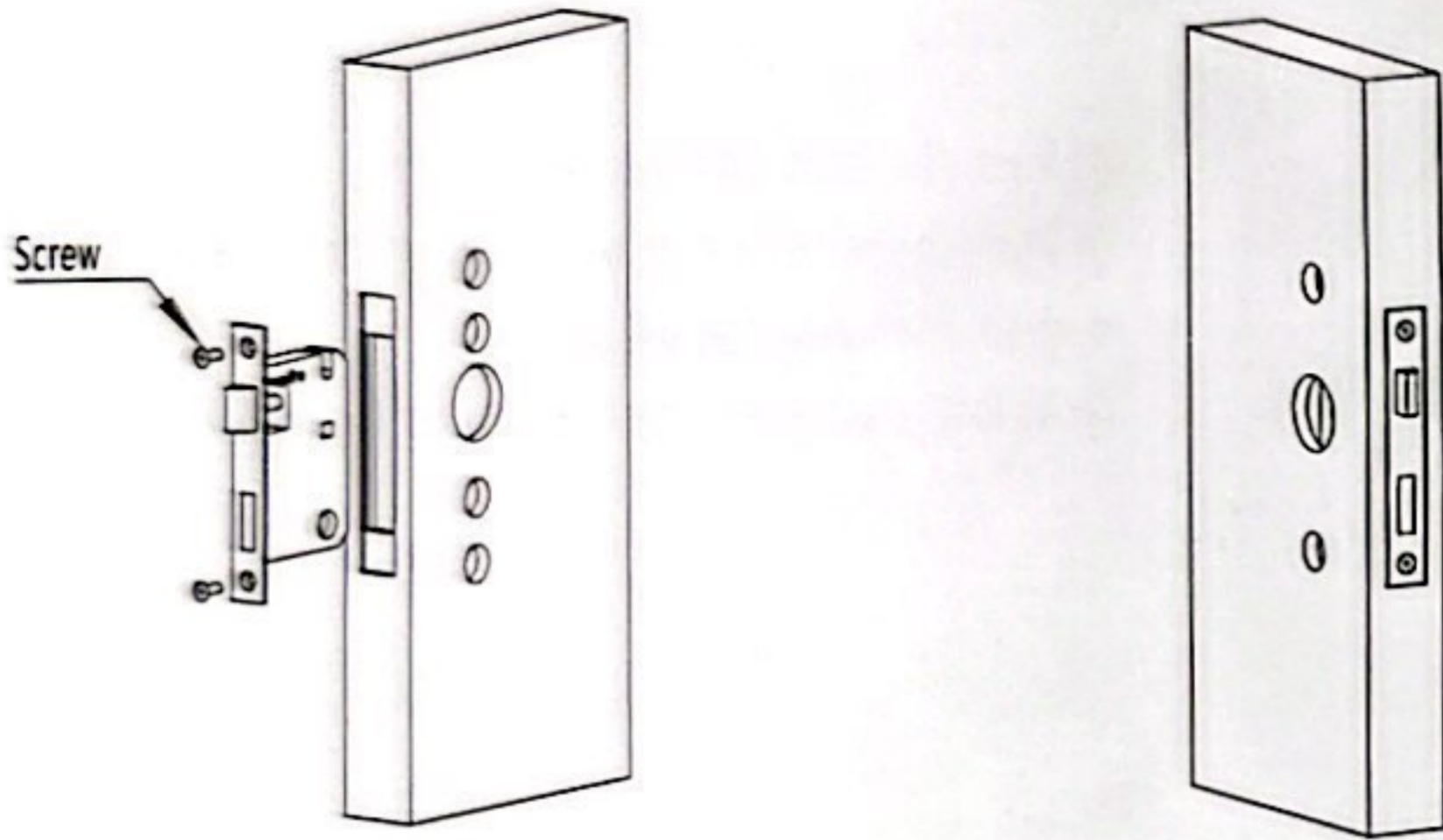

Put the lock body into the door frame which is processed with the specified dimension, and then tighten two screws.

## 2.Front panel installation

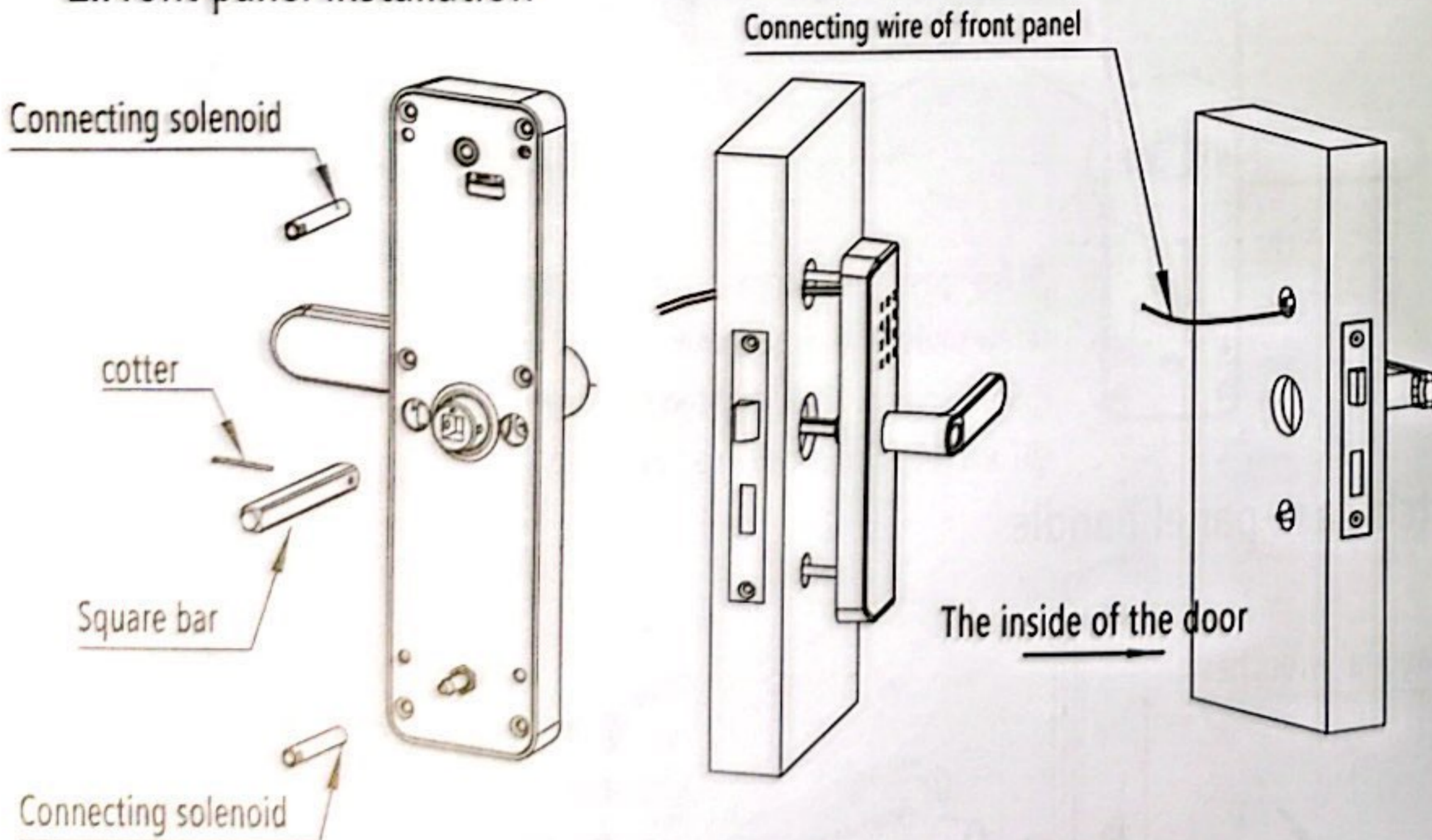

Tighten 2 connecting screws on the front panel. Use the cotter to fix the square bar on the lockup clutch.

Let the front panel connecting wire pass through the hole, and let the front panel cling to the outer door.

6

## 3.Back panel installation

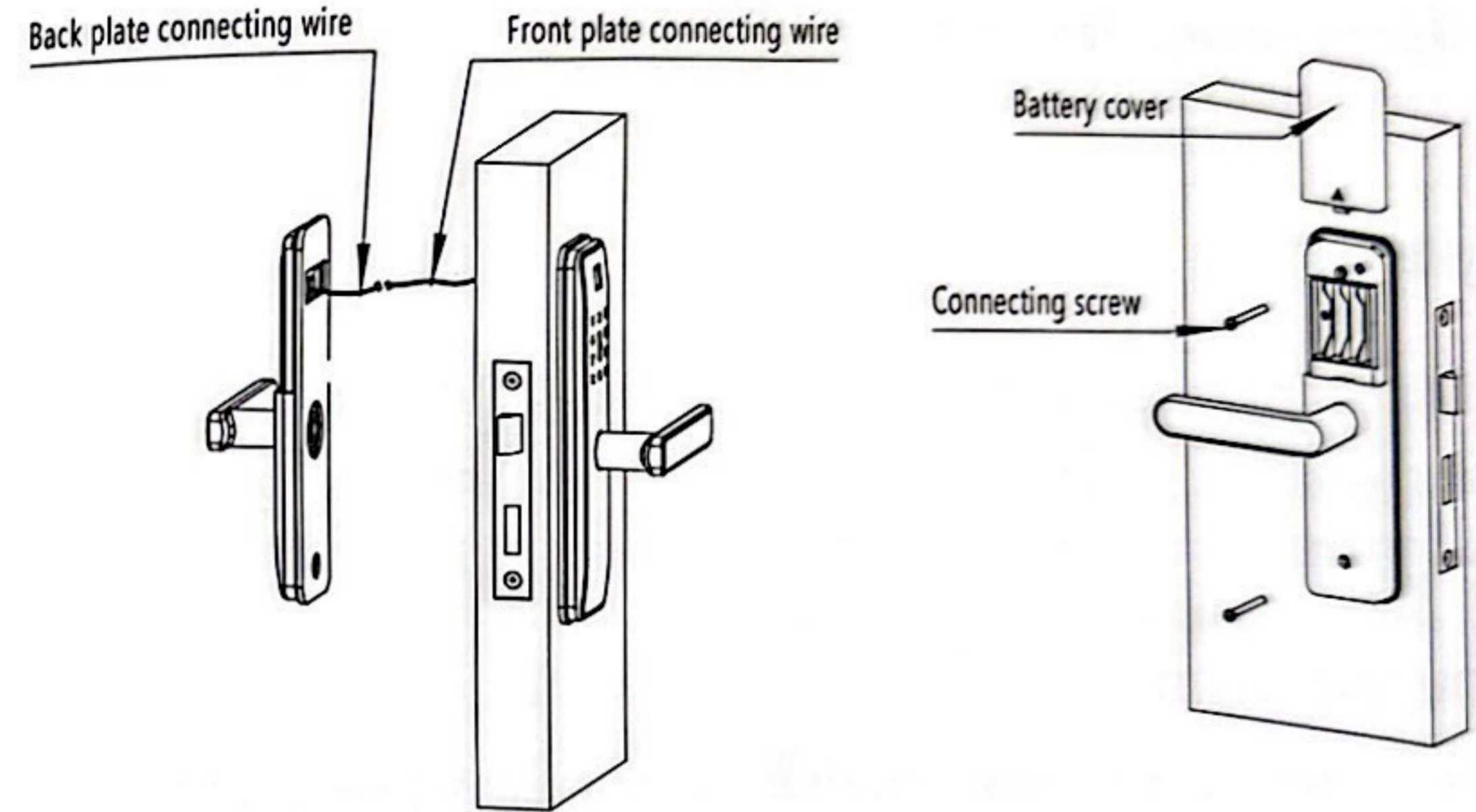

Front plate connecting wire and back plate connecting wire.

Remove the battery cover, align the back lever handle to square bar and insert it in, make the back plate cling to the door panel. Tighten 2 connecting screws. After install in the battery, make sure all the parts are in appointed position, and then close the battery cover.

## Installation test

Twist both inside and outside lever handle, mechanical key etc. Double check all units are working.

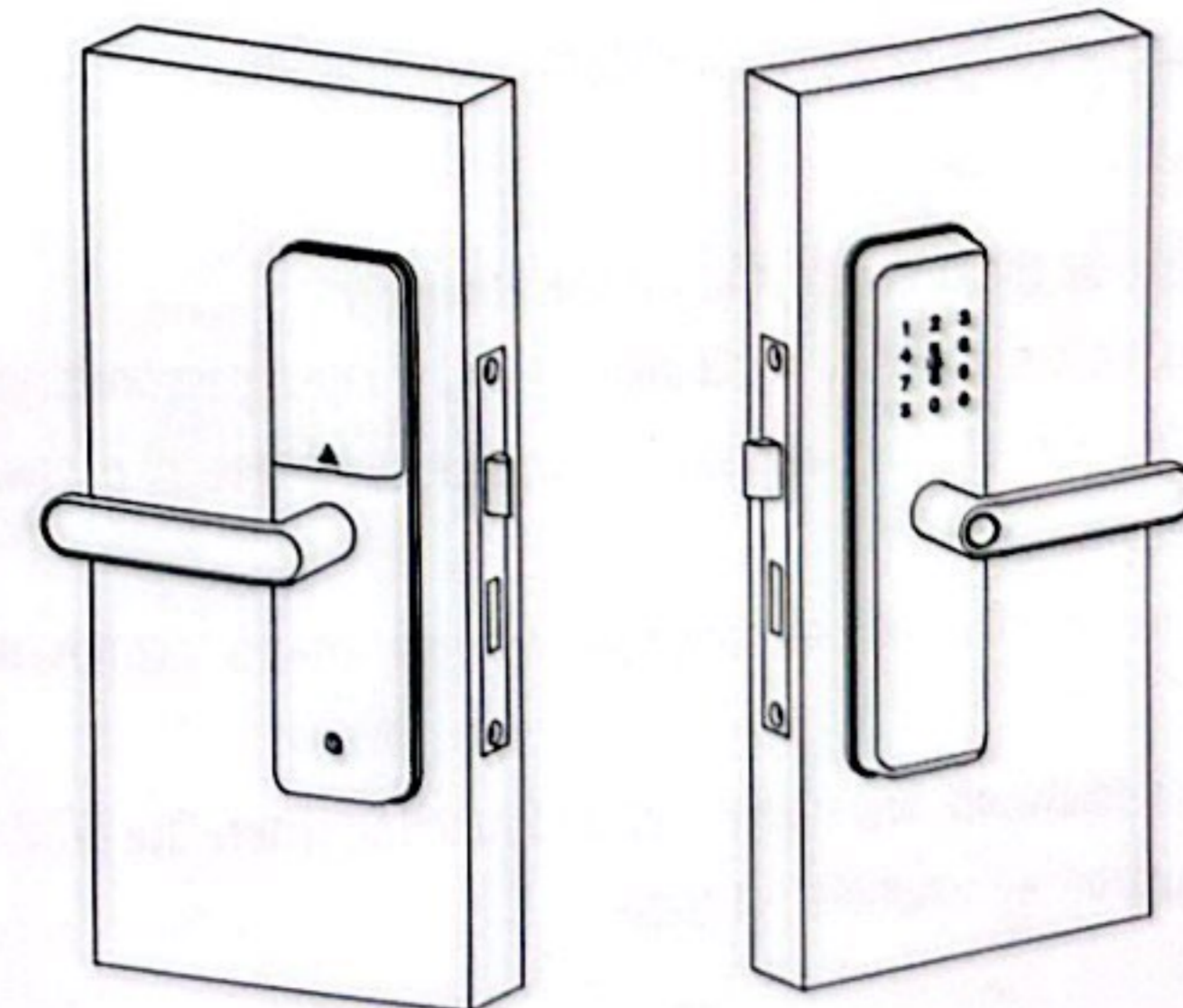

7

# Function introductions

## 1.Unlocking mode

Fingerprint unlocking, Password unlocking, Card unlocking, Emergency key unlocking (emergency condition only)

## 2.System capacity

Unlocking mode	Administer	Fingerprint	Password	Card
Capacity	1	120	150	200

## 3.Emergency power

When the smart lock is out of power or the battery do not have enough power to open the lock, USB power is available. Connecting the emergency power interface which is below the front panel unit directly, (The position of emergency power interface is showed in product detailed drawing in second page) the system could be activated to open the door normally. (Please replace the battery after)

# Product setting

## 1.Initial state

This product adopts the classification permission management,the types of users could divide into administer user and ordinary user,administrator has the maximum authority where ordinary user only have door opening authority.At initial state,there is no administer user,the first user who is added could be administered by password or cellphone application .

## 2.Operating rule

- 1.Press any key to wake up the keyboard.# Key is the enter key.
- 2.When input the password,press \* Key could delete the last input password number.After delete all passwords ,if in the Add User Mode,could quit this mode.After delete all passwords ,press 3 times \*Key,the screen out.
- 3.Every time open the lock, will give 5 seconds opening time, after 5 seconds, it will lock automatically.
- 4.This product contain password, fingerprint and card function. There are 6-12 digits valid for password, and it is supporting scramble pin code.

## 3.Operation instruction

### 1.Add administer

When the administrator password is not set, or the mobile phone administrator is not added,enter " \*12#" or short press SET button,the lock hint:please input administrator pass-code ,after that enter " 123456#" ,enter 6-12 digit administrator code,press "#" Key to confirm the prompt to enter again, if the two passwords are the same, the lock will prompt operation is successful.

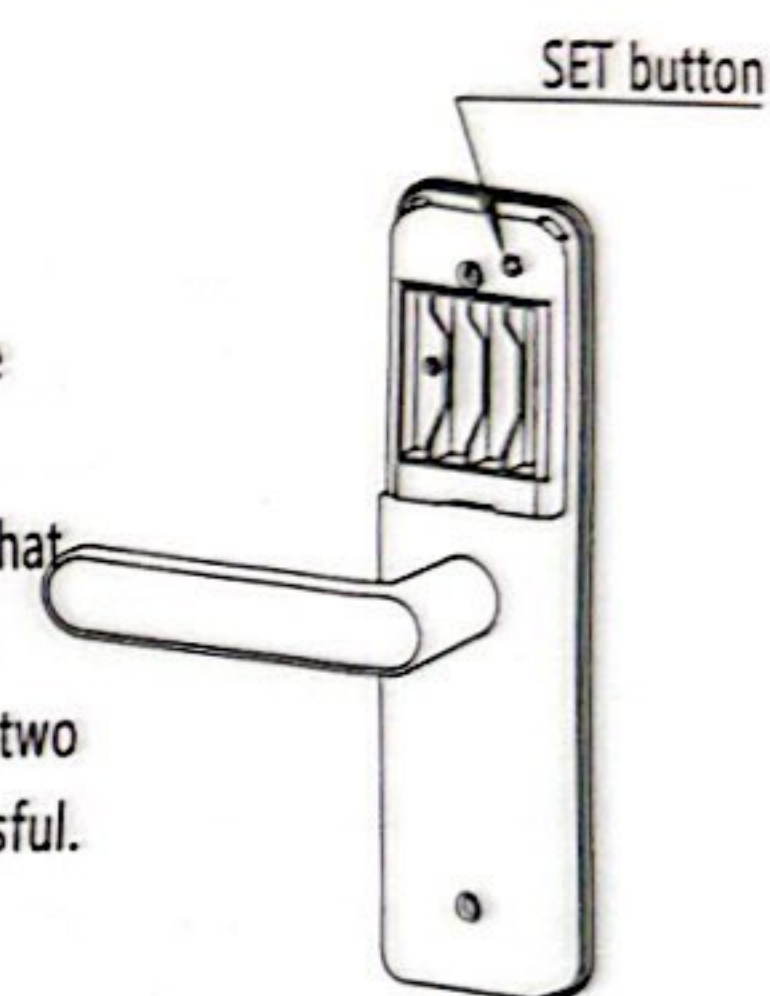

### 2.Adding users

Add password user: enter "\*\*85#" or press the reset button, the door lock prompt: please input administrator pass code, after the verification is completed, the voice prompt please enter the fingerprint or password, enter the 6-12 digit password, press the "#" key to confirm the prompt to enter again, if the password is matched both, the door lock hint operation is successful.

Add fingerprint user:input "\*\* 85# " or short press reset button, the door hint: please input administrator pass code, after completion of validation, voice prompt enter the password or fingerprint,put finger to add fingerprint, door lock will prompt three times to add same fingerprint, if it is same fingerprint for 4 times, the lock will show you "operation successful" .During entering fingerprint,please keep your finger as flat as you can on the fingerprint sensor area.

Add fingerprint user:input "\*\* 85# " or short press reset button, the door hint:please input administrator pass code, after completion of validation, voice prompt enter the password or fingerprint or card,put the card which required to be added near the keyboard within 2cm,the lock will hint "operation successful" .

### 3.Password modification

enter "\*\*10#" , door lock prompt: please input the original pass code, after the input is completed, the voice prompt please enter a new password, enter the 6-12 digit password, it will required to enter again after press the "#" key , if the password is matched both, the lock will hint :operation successful" . (administrator password use "\*\*12#" to change)

### 4.Delete user

Delete password user: enter "\*\*71#" , door lock prompt:please input administrator pass code,the lock will hint :operation successful" after verification. All password users will be deleted. (the administrator password will not be deleted)

Delete fingerprint user: enter "\*\*70#" , door lock prompt:please input administrator pass code,the lock will hint :operation successful" after verification. All fingerprint users will be deleted.

Delete card user: enter "\*\*69#" , door lock prompt:please input administrator pass code,the lock will hint :operation successful" after verification. All card users will be deleted.

## 4.Factory reset

Long press the SET button,after hear" Please input initialization pass code" ,input "000#" .The lock will recover to the factory setting and delete all the fingerprint,password,card and cellphone administer.

## 5.Open mode

Input" \*666#" ,the lock will show a hint:Please verify the administer identity.After that,start the Open mode.When the lock is on Open mode,it will not automatically lock up.Once the user verify the identity again,the Open mode will be canceled.

## 6.Other instruction

- 1.If verifying unsuccessful for more than 5 consecutive times,the keyboard will be locked for 5 minutes automatically .After 5 minutes,will unlock the keyboard.During the disabled lock state,verify fingerprint user or IC card user or cellphone application user could release keyboard lock state.
- 2.The scramble Pin code is available for the smart lock. For example, your setting password is 123456, it is possible to open the lock if you enter the password 0021341234563694, it has 16 digits in total for scramble pin code and valid password together, and this function could prevent peeping.
- 3.If the power of the battery is lower than 4.8V,wake up the keyboard,the voice prompt:" the power is low,please replace the battery" ,and it is flicker for 1 second.After verify fingerprint/IC card/password ,the voice hint " the power is low,please replace the battery" before unlock the door.
- 4.This product supporting bilingual ,both English and Chinese is switchable ,enter" \*39#" ,the lock will hit enter administrator password,enter "#" Key to confirm,then enter "1#" to switch to Chinese,enter "2#" to switch to English.(note: the administrator password is replaced by "123456" when the administrator is not added)